

APCV

236 Av ampere
30600 Vauvert

Tel : 04 66 71 60 31/ 06 11 19 36 22

Fax : 04 66 71 55 09

MACASSAR

Fiche technique cloture de piscine vitrée

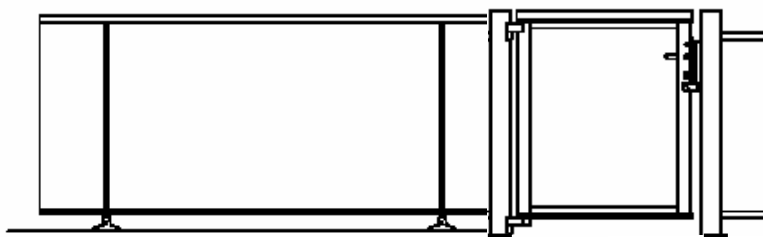

CLOTURE VITREE CONFORME **NFP 90306.**

HAUTEUR 1100- ESPACE MAXI ENTRE POTEAUX 2000 – VERRE FILANT
DIMENSION 968 * LONGUEUR – POLI SUR HAUTEUR .

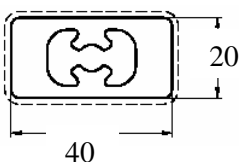
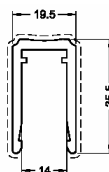
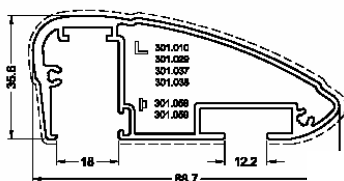
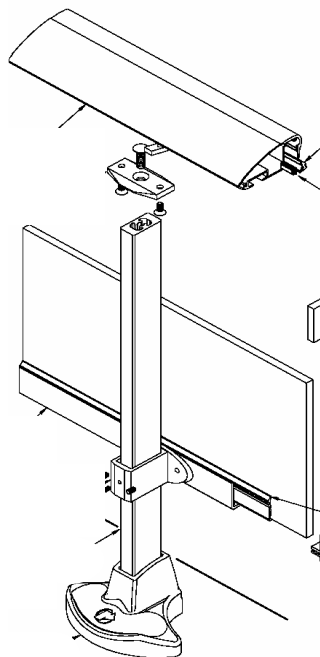

PORTILLON

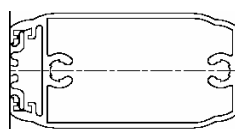
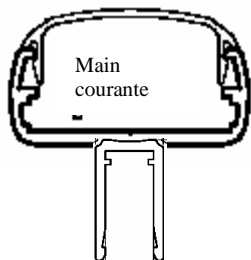
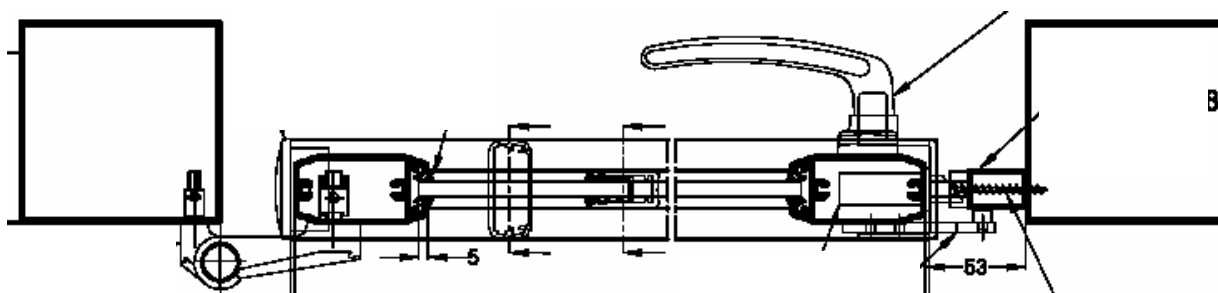

Montant