

# APCV

236 Av ampere  
30600 Vauvert

# Fiche technique clôtures de piscine barreaudée

Tel : 04 66 71 60 31/ 06 11 19 36 22

Fax : 04 66 71 55 09

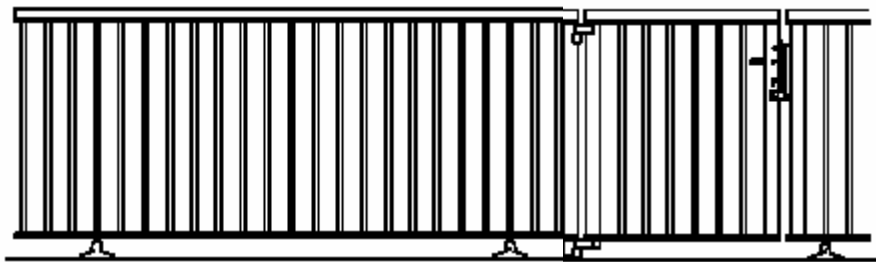

MACASSAR

CONFORME **NFP 90306.** HAUTEUR 1220- ESPACE MAXI ENTRE POTEAUX 2000

## Poteaux- Montant fort

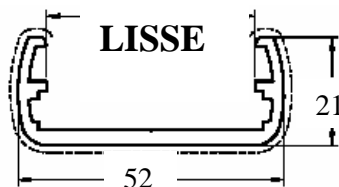
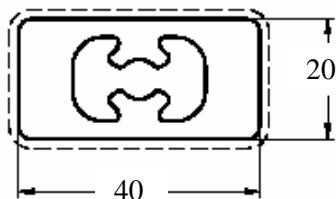

## BARREAU

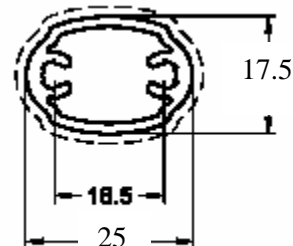

## MAIN COURANTE

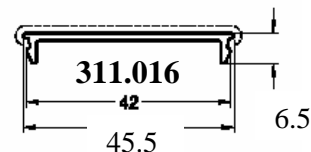
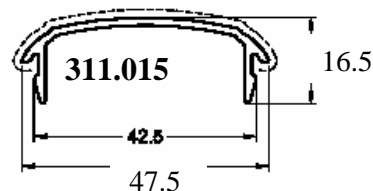
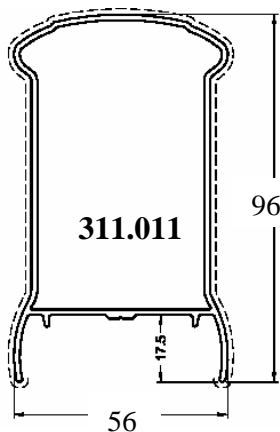
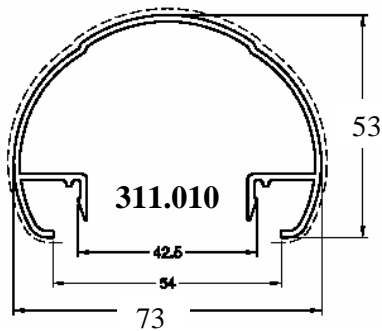

## ACCESSOIRES

